



H360 Series High Performance Medium Pressure Filter

Flows to 114 L/min (30 USgpm) 210 bar (3000 psi)

Service Data

H360 Series High Performance Medium Pressure Filter

Flows to 114 L/min (30 USgpm) 210 bar (3000 psi)



CAUTION

Before servicing the element, the bleed plug in filter housing must be loosened to relieve hydraulic pressure. This will minimize fluid overflow.

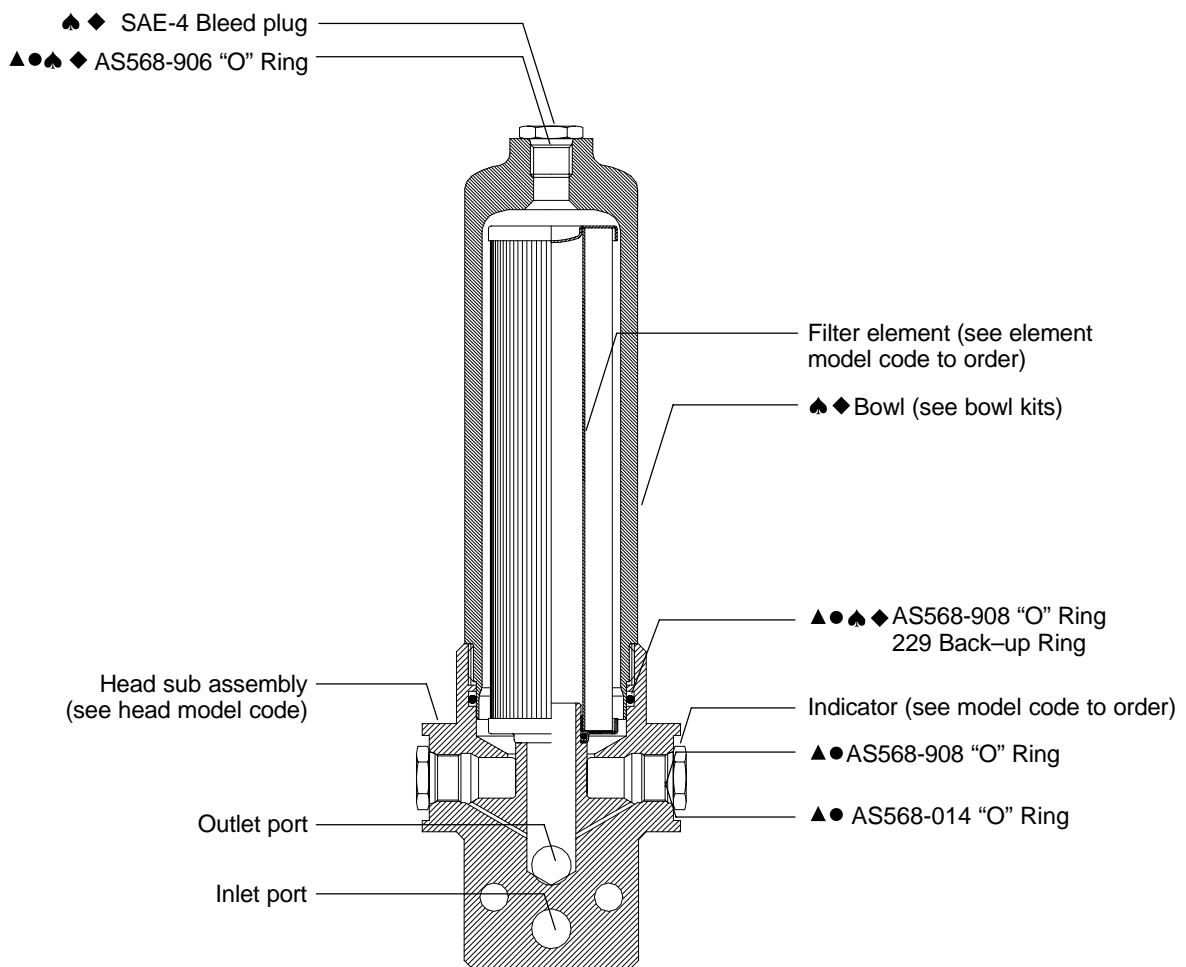

NOTE: Bowl kits contain Buna-N seals, to order Viton seals, replace **B** in part number with a **V**.

Example:

From: P-133238-01**B**, for Buna.

To: P-133238-01**V**, for Viton.

- ▲ Included in seal kit P-427466-34 Buna
- Included in seal kit P-427466-36 Viton
- ◆ Included in 4" Bowl kit P-133238-01B
- ◆ Included in 8" Bowl kit P-133238-02B

Servovalve Sandwich Plates

Design Specifications

Sandwich plates are available to mount the H360 Series filter with a Vickers SM4-20 and SM4-40 series servovalves. In addition, standard sandwich plates are available for mounting either CETOP3 or CETOP5 valves.

Sandwich plates are supplied with Viton seals. Sandwich plate mounting bolts are available and must be ordered separately. Refer to the table below for bolt kit numbers.

Sandwich Plate Material	Weight	
	SM4-20 Kg (lbs)	SM4-40 Kg (lbs)
Steel	5,9 (13.0)	7,3 (16.0)

Model	Sandwich Plate	Bolt Kit	Bolt Size
SM4-20	P-233639	BKDGFN01624	1/4-20 x 4-1/2"
SM4-40	P-233640	BK590735	5/16-18 x 5-1/4"
CETOP3	P-334115	*	*
CETOP5	P-334116	*	*

* Bolt kits will vary with valves and sandwich plates. Refer to Vickers Drawing I-521750 for available kits.

Dimensions

mm (inch)

Model	A	B	C	D	E	F	G	H	I	J	K	L	M	N	O	P	Q
SM4-20	120,7 (4.75)	50,8 (2.00)	65,0 (2.56)	30,2 (1.19)	50,8 (2.00)	4,45 (1.75)	22,4 (0.88)	12,7 (0.50)	9,9 (0.39)	63,5 (2.50)	25,7 (1.01)	13,0 (0.51)	25,4 (1.00)	50,8 (2.00)	46,0 (1.81)	23,1 (0.91)	101,6 (4.00)
SM4-40	139,7 (5.50)	57,2 (2.25)	60,5 (2.38)	32,5 (1.28)	63,5 (2.50)	92,2 (3.63)	22,4 (1.81)	20,6 (0.81)	20,6 (0.81)	63,5 (2.50)	25,7 (1.01)	13,0 (0.51)	25,4 (1.00)	63,5 (2.50)	22,4 (1.81)	23,1 (0.91)	127,0 (5.00)

Model	aa	bb	cc	dd	ee
SM4-20	2,5 (0.10 dia) 4,0 (0.16 DP)	8,6 (0.34 dia)	16,0 (0.63 dia)	8,3 (0.33 dia)	13,5 (0.53 dia)
SM4-40	4,06 (0.16 dia)	14,7 (0.58 dia)	16,0 (0.63 dia)	8,3 (0.33 dia)	22,1 (0.87 dia)

NOTE: SM4-20 cover must be rotated 90° for use with this assembly.

SM4-40 sandwich plate shown

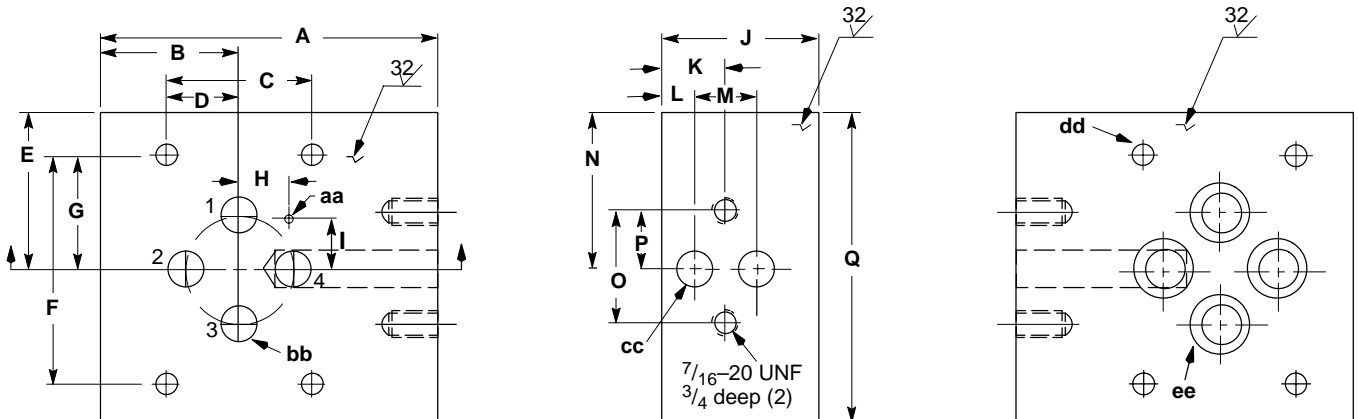

Proportional Valve Sandwich Plates

Dimensions

mm (inch)

CETOP 3 P-334115

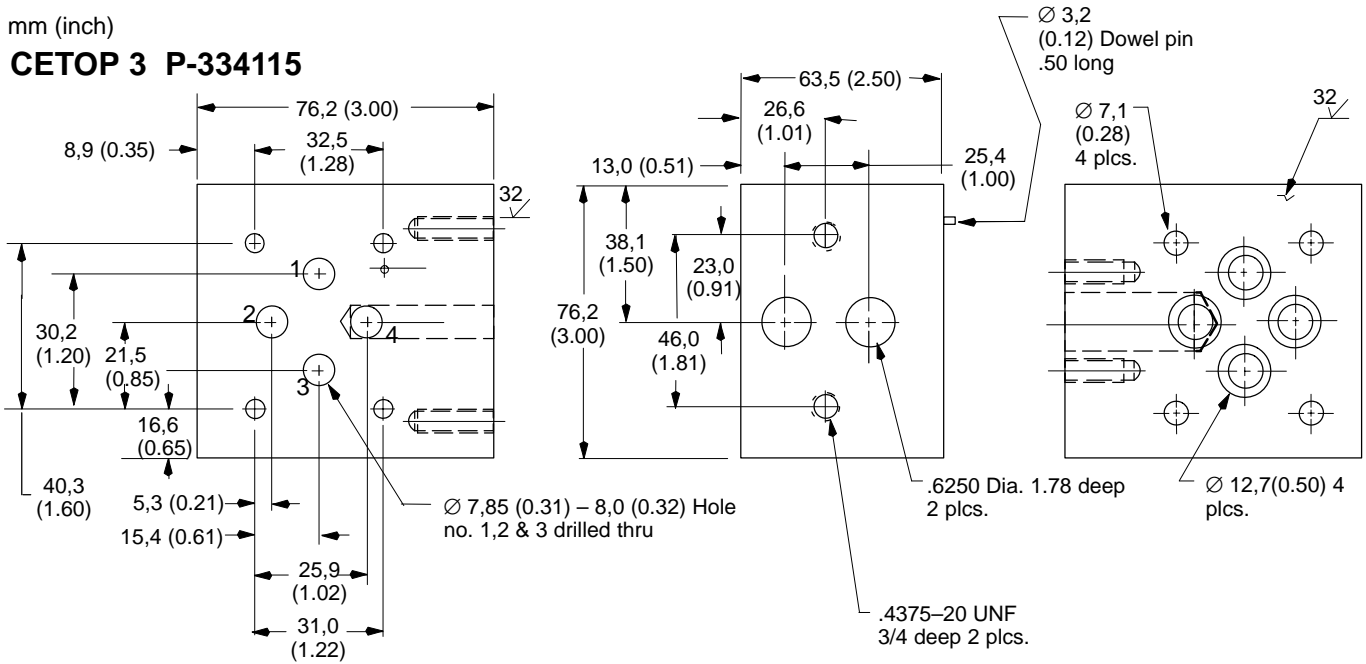

CETOP 5 P-334116

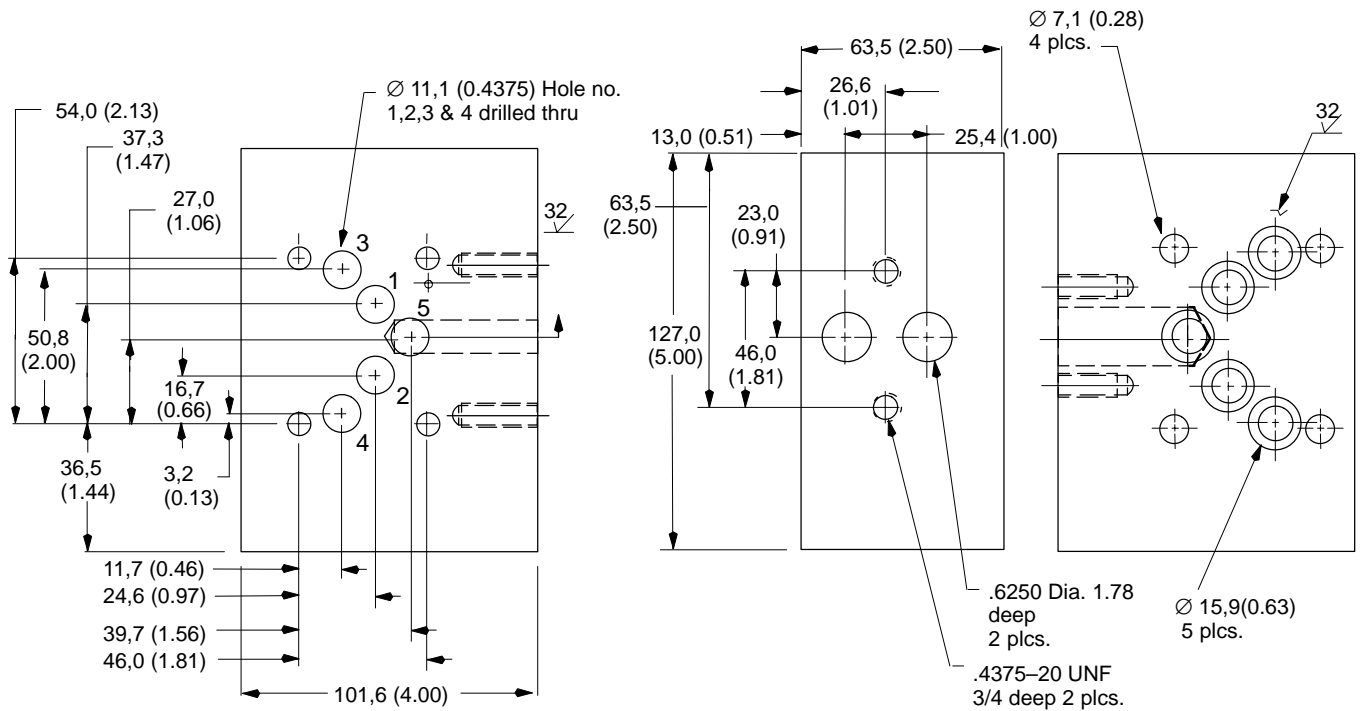

Head Sub Assembly Model Code

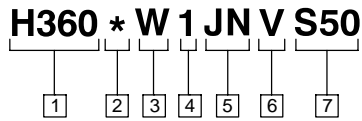

1 Filter series

H360

2 Element collapse rating

1 – 150 PSI (10 bar) (flushing only)
4 – 3000 PSI (210 bar)

3 Port option

W – Sandwich plate mount – vertical bowl

4 Valve option

1 – Non-bypass

5 ΔP indicator & receptacle options

First designator (Indicator type)

J – No ΔP indicator

Second designator (Electrical receptacle)

N – No receptacle – Use with visual ΔP indicator

6 Seal material

V – Viton–A

7 S50 Head sub assembly

Element Model Code

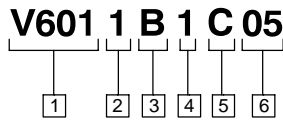

1 Filter element

V601 – For use with H360 series filters

2 Element collapse rating

1 – 150 PSI (10 bar)
4 – 3000 PSI (210 bar) (H-pak only)

3 Seal material

B – Buna–N
V – Viton–A

4 Bowl length mm (in)

1 – 250,2 (98.5)
2 – 342,4 (13.48)

Element length mm (in)

101,6 (4)
203,0 (8)

5 Element construction

C – C-pak media with epoxy bond (150 PSID collapse) grade 3, 5, 10
H – H-pak high collapse media (3000 PSID collapse) grade 3, 10

6 Fluid cleanliness ratings

Code	Fluid cleanliness level
03	11/14/12 or better
05	18/16/14 or better
10	20/18/15 or better

The table above assumes limited ingress and a single pass of pump flow through the element. For more detailed information, please consult Vickers Guide to Systemic Contamination Control **561** or contact your local Vickers Distributor.

Differential Pressure Indicator Model Code

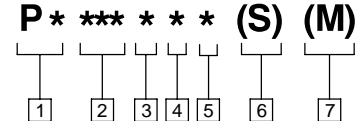

1 Style option

PV – Visual
PE – Electrical
PD – Electrical/Visual

2 Actuation pressure option

015 – 15 ± 4 PSID (1 bar)
035 – 35 ± 5 PSID (2,4 bar)
070 – 70 ± 7 PSID (4,8 bar)
(not an option with 330/340 filters)
100 – 100 ± 12 PSID (6,9 bar)

3 Thermal lockout option

N – No thermal lockout (not an option with IFI indicator)
T – Thermal lockout (standard TLO=80 ± 20° F)

4 Seal option

1 – Buna–N
2 – Viton

5 Receptacle option

B – 5-pin Brad Harrison (41512) (not an option with visual indicator)
H – Hirschman (DIN 43650) (not an option with visual indicator)
N – No receptacle (use with visual indicator) (not an option with IFI indicator)

6 Surge control option

None – No surge control
S – Surge control (not an option with 330/340 filters)

7 Filter series option

None – Standard
M – 330/340 Filters only

Eaton
Fluid Power Group
Hydraulics Business USA
14615 Lone Oak Road
Eden Prairie, MN 55344
USA
Tel: 952-937-9800
Fax: 952-294-7722
www.eaton.com/hydraulics

Eaton
Fluid Power Group
Hydraulics Business Europe
Route de la Longeraie 7
1110 Morges
Switzerland
Tel: +41 (0) 21 811 4600
Fax: +41 (0) 21 811 4601

Eaton
Fluid Power Group
Hydraulics Business Asia Pacific
11th Floor Hong Kong New World Tower
300 Huaihai Zhong Road
Shanghai 200021
China
Tel: 86-21-6387-9988
Fax: 86-21-6335-3912